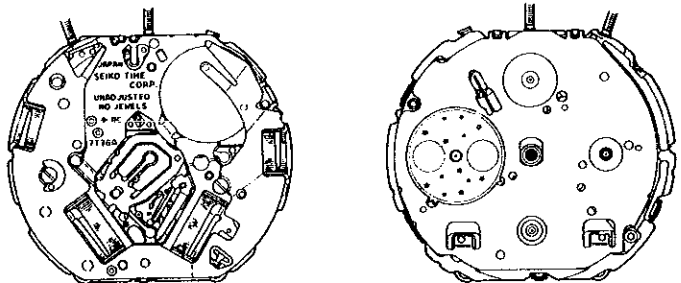

PARTS CATALOGUE / TECHNICAL GUIDE

Cal. 7T24A, 7T34A Cal. 7T36A, 7T44A

[SPECIFICATIONS]

Cal. No.		7T24A	7T34A	7T36A	7T44A
Item					
Movement		 <p>The illustrations refer to Cal. 7T36A. (x 1.5)</p>			
Movement size	Outside diameter	ϕ 27.6mm 24.0mm between 3 o'clock and 9 o'clock sides			
	Casing diameter	ϕ 27.0mm 24.0mm between 3 o'clock and 9 o'clock sides			
	Height	3.1mm (3.4mm*)		3.7mm (4.0mm*) 3.1mm (3.4mm*)	
Time indication	Main time	Hour, minute and small second hands			
	Calendar	Date hand		Date hand and moon phase indicator	Date hand
	Stopwatch	Minute and 1/5-second hands			
	Alarm	-	Small hour and minute hands		
	Timer	-			Minute and second hands (Stopwatch 1/5-second and minute hands)
Driving system		Step motor, 3 pieces		Step motor, 4 pieces	

* Including the battery portion.

	Cal. No.	7T24A	7T34A	7T36A	7T44A
Additional mechanism		Electronic circuit reset switch			
		Stopwatch hands 0-reset adjustment function			
		Battery life indicator (small second hand)			
		Instant setting device for date hand			
		-		Instant setting device for moon phase indicator	-
		Stopwatch function (Up to 30 minutes in 1/5 seconds) • Accumulated elapsed time measurement • Split time measurement			
		-	Alarm function (12-hour indication system)		
			-	Timer function (Up to 60 minutes in minutes)	
Loss/gain		Monthly rate at normal temperature range: less than 15 seconds			
Regulation system		Nil			
Measuring gate by quartz tester		Use 10-second gate.			
Battery		SEIKO SR927SW, Maxell SR927SW, SONY SR927SW, EVEREADY 395	SEIKO SR927W, Maxell SR927W, SONY SR927W, EVEREADY 399		
		Battery life is approximately 2 years. Voltage: 1.55V			
Jewels		0 jewel			

PARTS CATALOGUE

Cal. 7T24A

Disassembling procedures Figs. :	①	→	⑥④
Reassembling procedures Figs. :	⑥④	→	①
Lubricating:	Types of oil		Oil quantity
	● Moebius A		○ Normal quantity
	○ SEIKO Watch Oil S-6		○ Extremely small
	○ Silicone oil 500,000 c.s.		

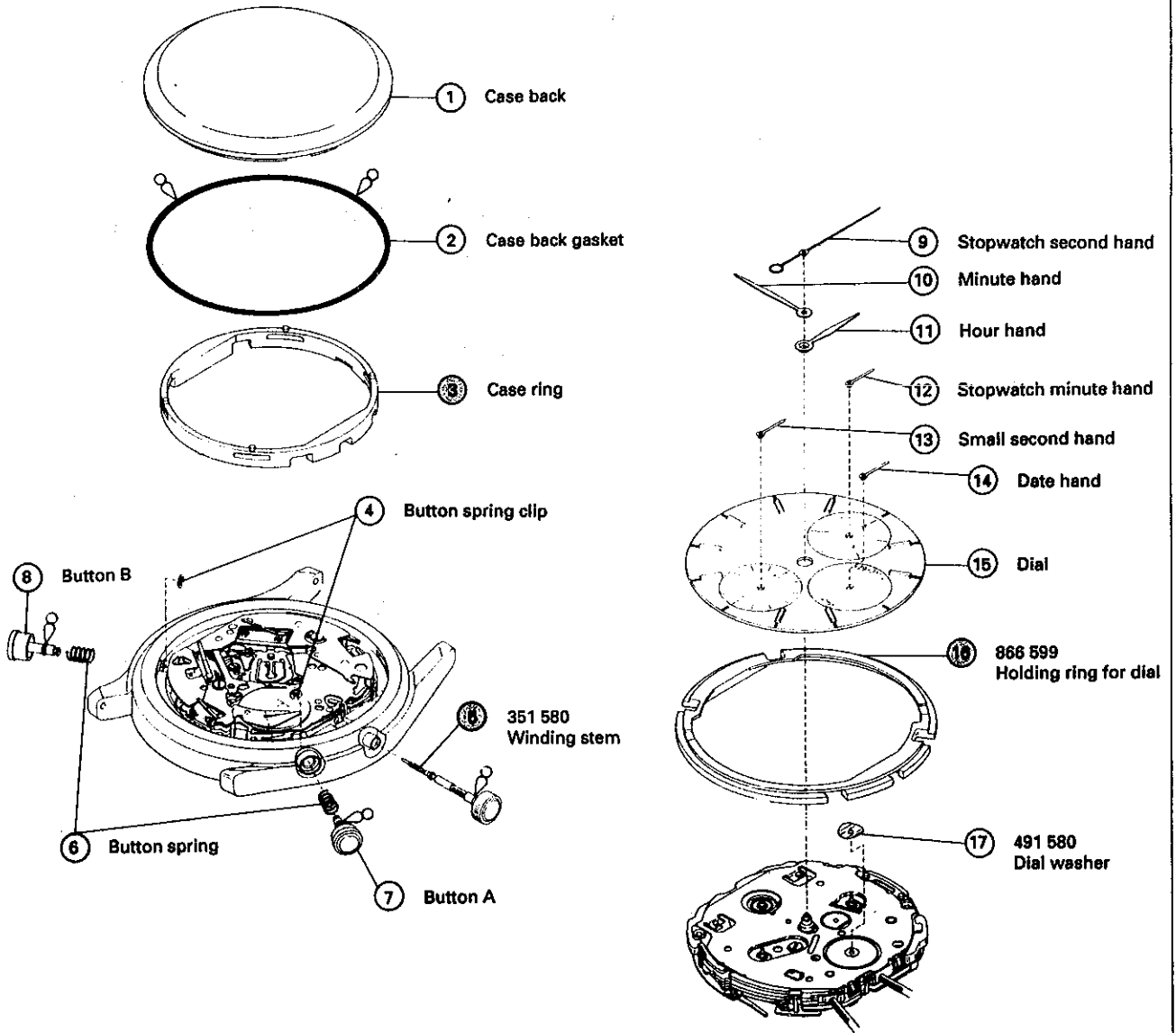

● → Please see the remarks on the following pages.

PARTS CATALOGUE

Cal. 7T24A

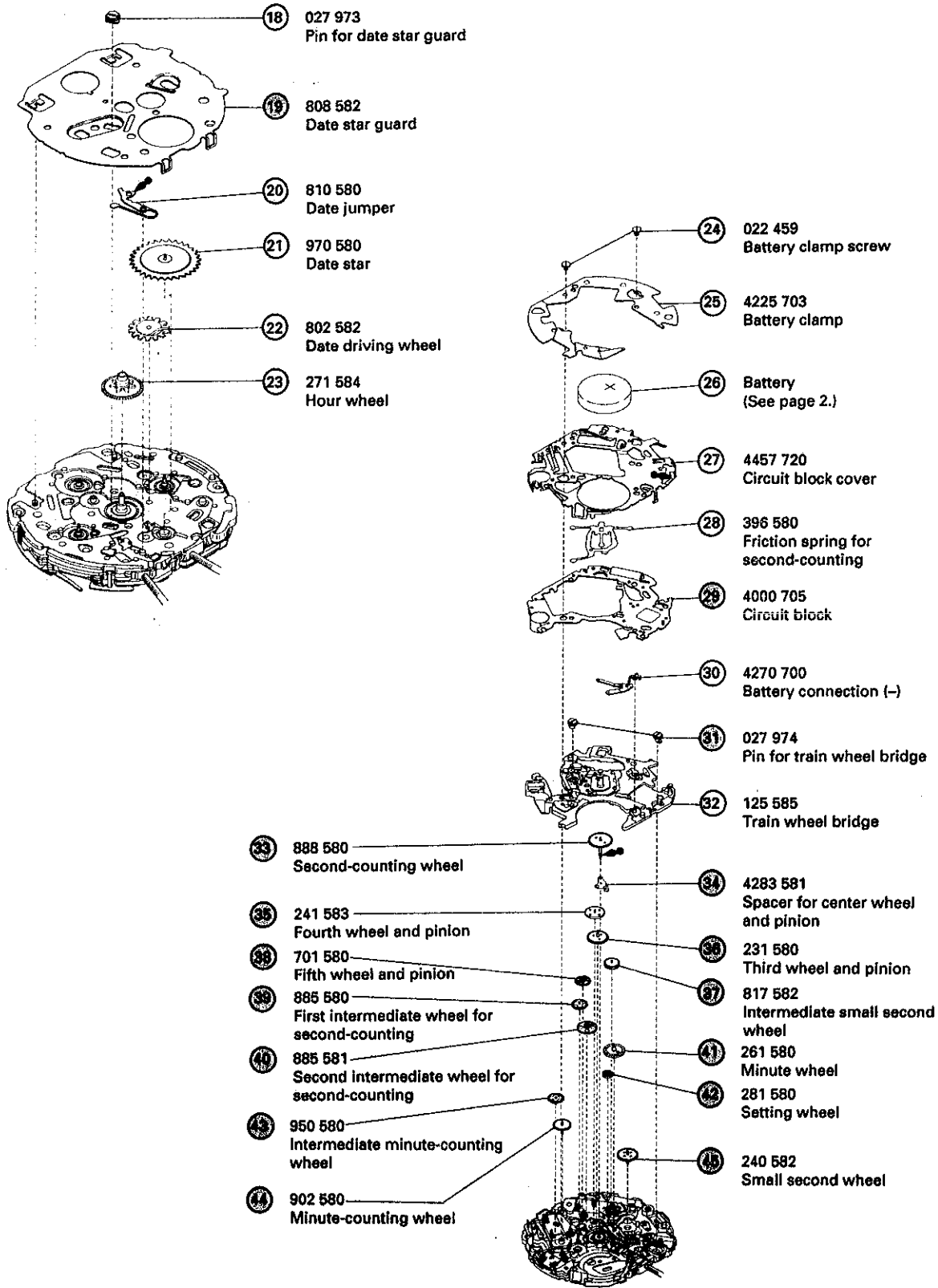

Please see the remarks on the following pages.

PARTS CATALOGUE

Cal. 7T24A

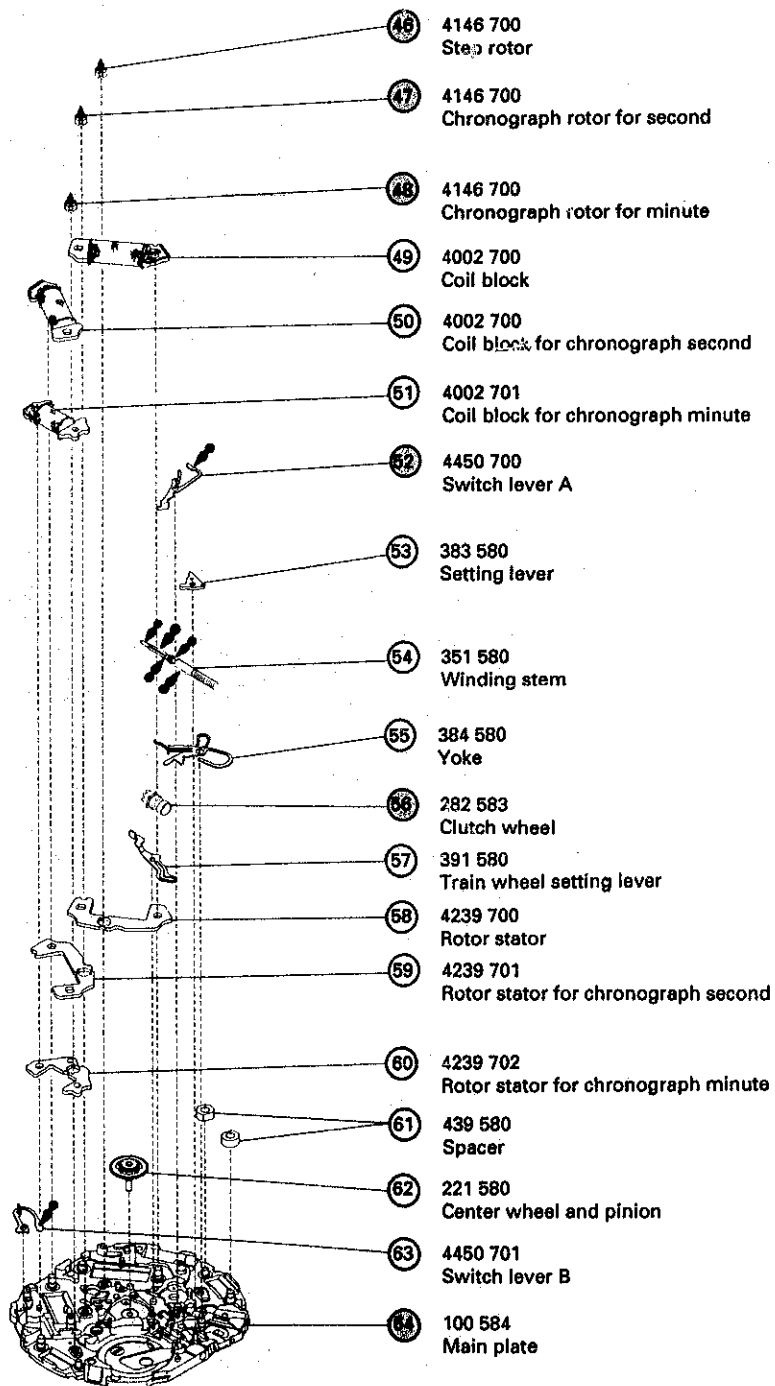

 Please see the remarks on the following pages.

PARTS CATALOGUE

Cal. 7T34A, 7T36A, 7T44A

Disassembling procedures Figs.:	[Cal. 7T34A]	1 → 10	11 → 28	35 → 85
	[Cal. 7T36A]	1 → 10	11 → 34	35 → 85
	[Cal. 7T44A]	1 → 10	11 → 29	35 → 85
Reassembling procedures Figs.:	[Cal. 7T34A]	85 → 35	28 → 11	10 → 1
	[Cal. 7T36A]	85 → 35	34 → 11	10 → 1
	[Cal. 7T44A]	85 → 35	29 → 11	10 → 1

Lubricating:	Types of oil	Oil quantity
●	Moebius A	∞ Normal quantity
∞	SEIKO Watch Oil S-6	∞ Extremely small
∞	Silicone oil 500,000 c.s.	

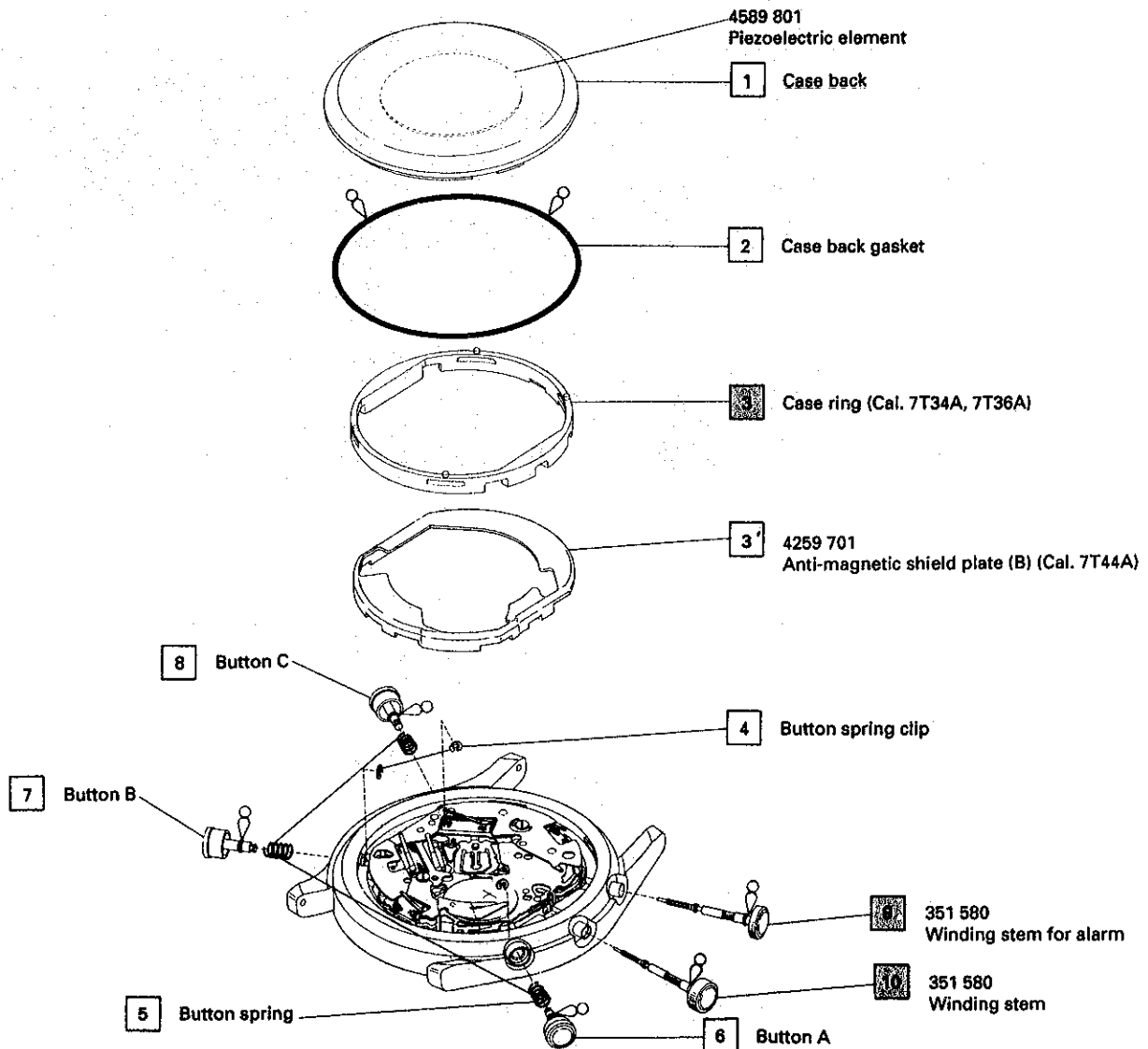

Please see the remarks on the following pages.

PARTS CATALOGUE

Cal. 7T34A, 7T44A

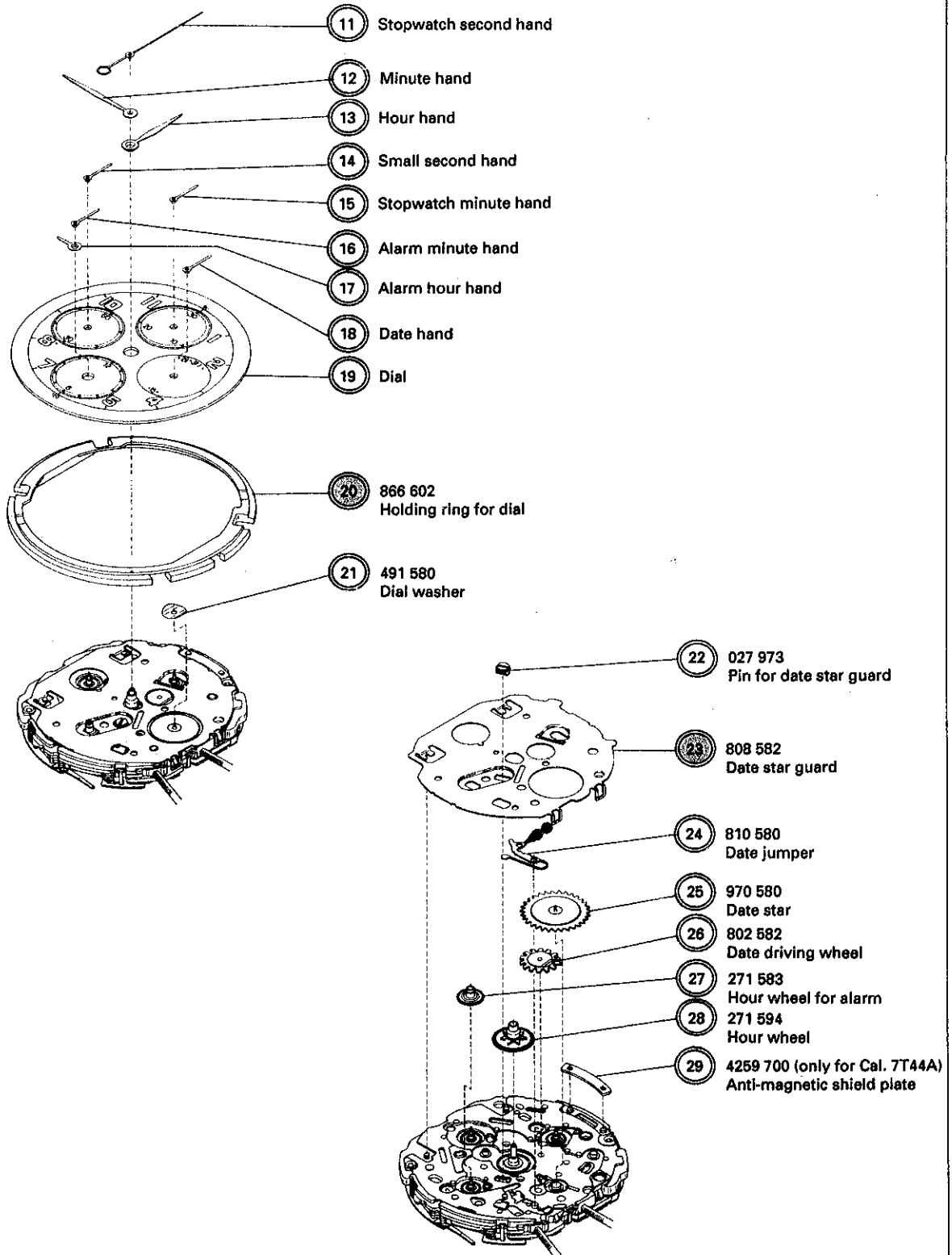

 Please see the remarks on the following pages.

PARTS CATALOGUE

Cal. 7T36A

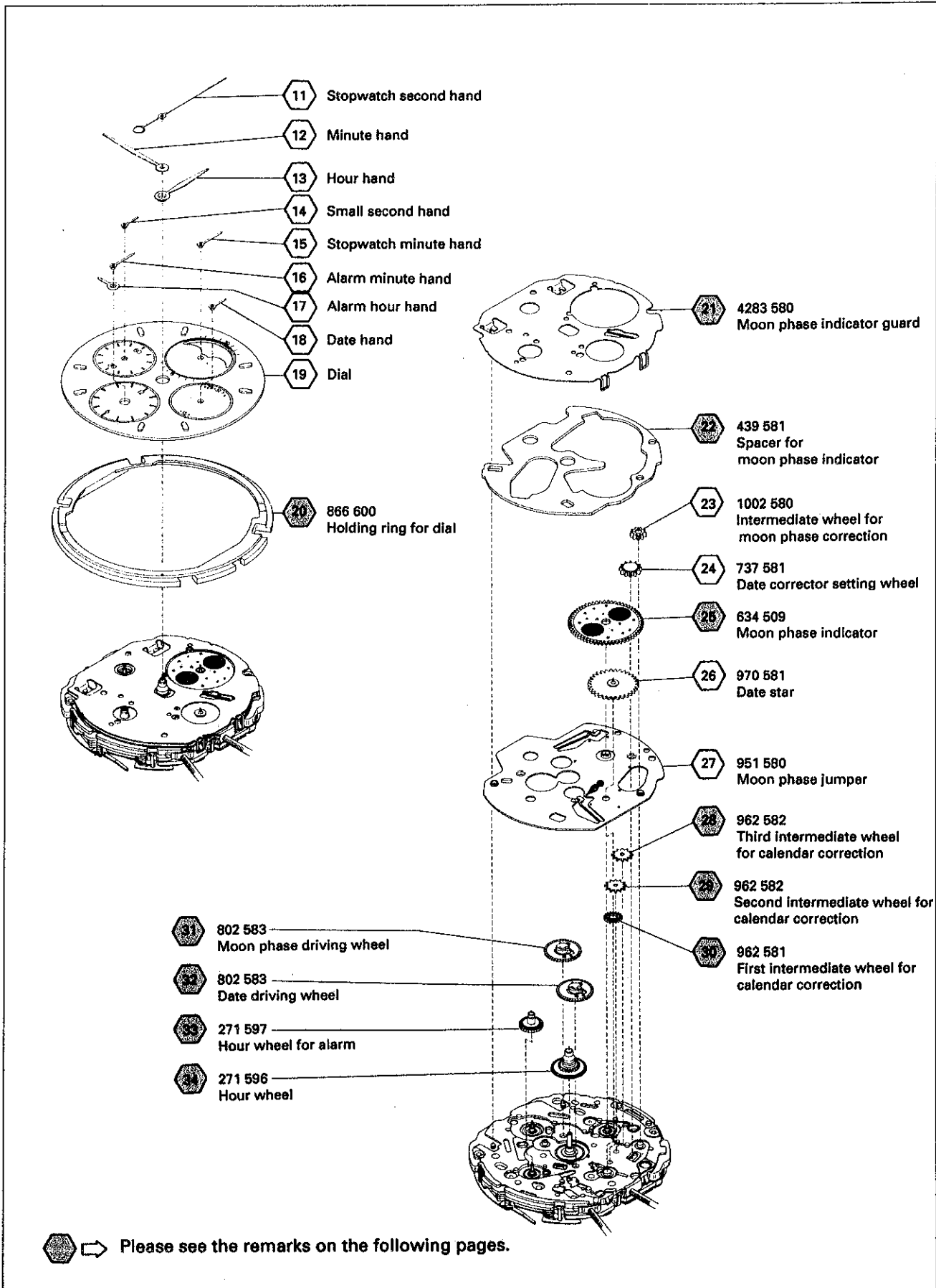

PARTS CATALOGUE

Cal. 7T34A, 7T36A, 7T44A

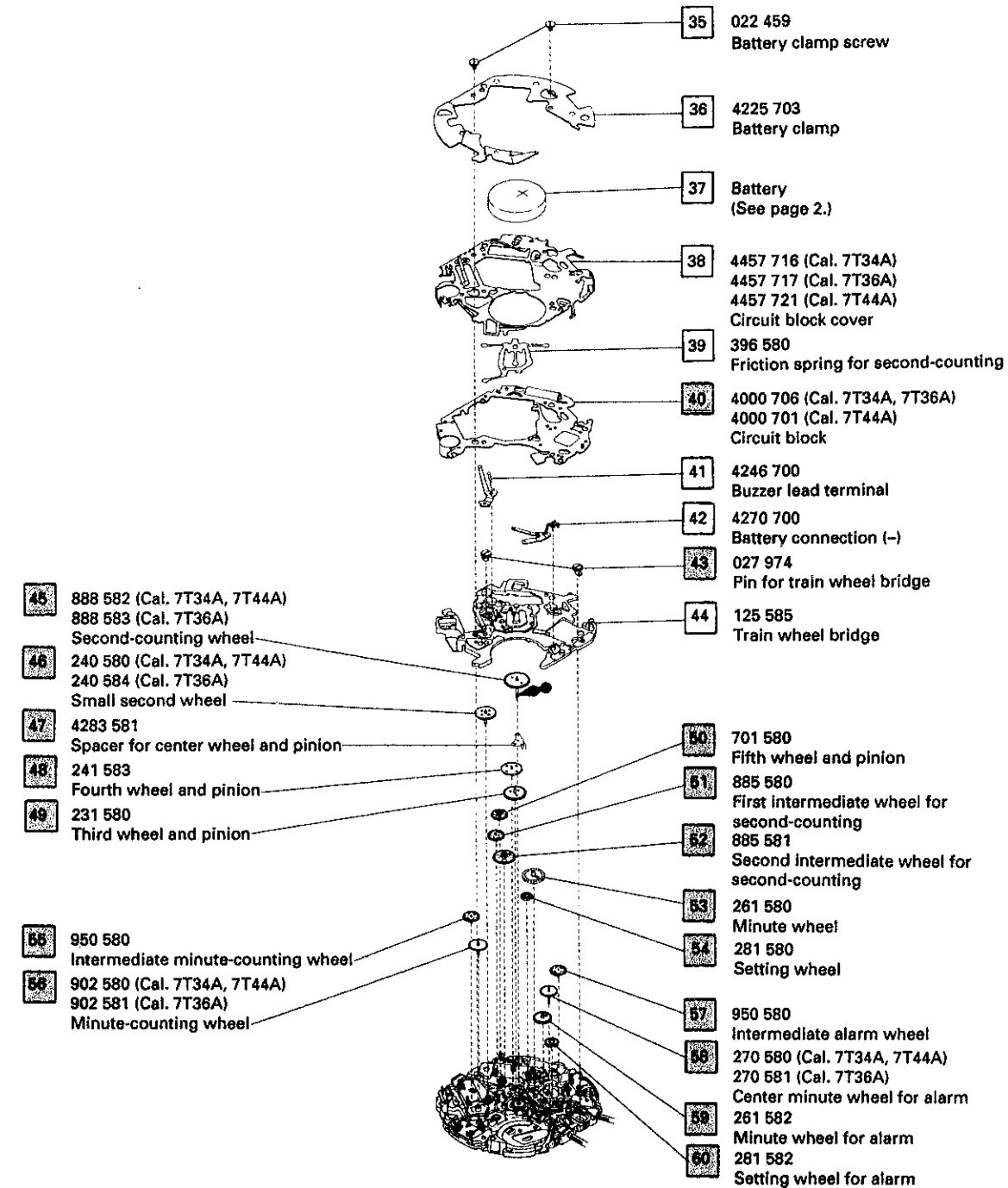

Please see the remarks on the following pages.

PARTS CATALOGUE

Cal. 7T34A, 7T36A, 7T44A

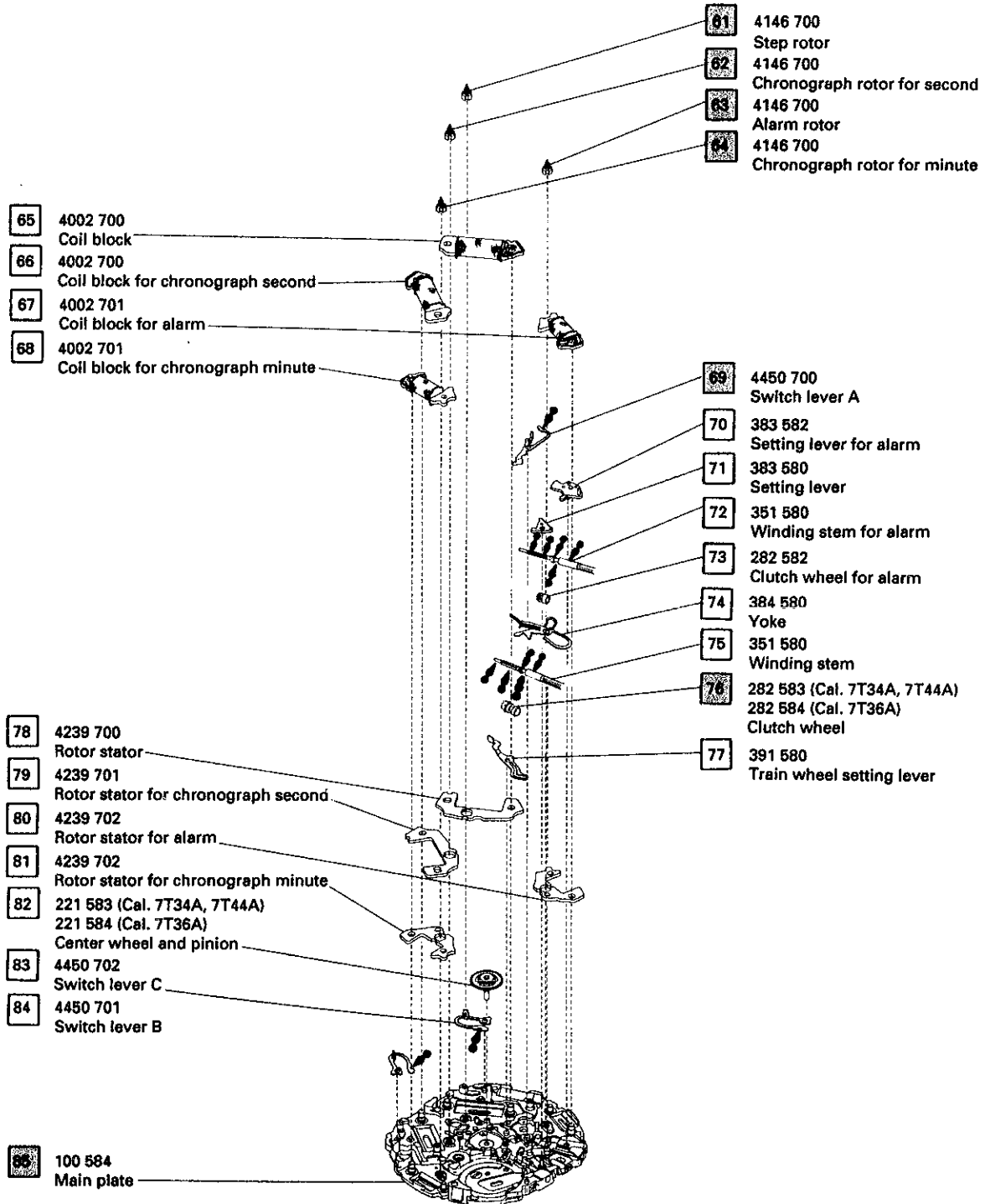

  Please see the remarks on the following pages.

PARTS CATALOGUE

Cal. 7T24A, 7T34A, 7T36A, 7T44A

Remarks:

③ 3 Case ring

Some models do not have a case ring.

The type of case ring is determined based on the design of cases.

Check the case number and refer to "SEIKO Casing Parts Catalogue" to choose a corresponding case ring.

⑤ 10 Winding stem

9 Winding stem for alarm

The type of winding stem and winding stem for alarm are determined based on the design of cases. Check the case number and refer to "SEIKO Casing Parts Catalogue" to choose a corresponding winding stem or winding stem for alarm.

⑬ ⑳ ⑳ Holding ring for dial

The type of holding ring for dial is determined based on the design of cases. Check the case number and refer to "SEIKO Casing Parts Catalogue" to choose a corresponding holding ring for dial.

⑳ 40 Circuit block

Circuit blocks for Cal. 7T series and Cal. 5T52A are the same in appearance.

To identify the circuit blocks for respective calibres, check the holes on the pattern as shown in the illustrations, referring to the table on the next page.

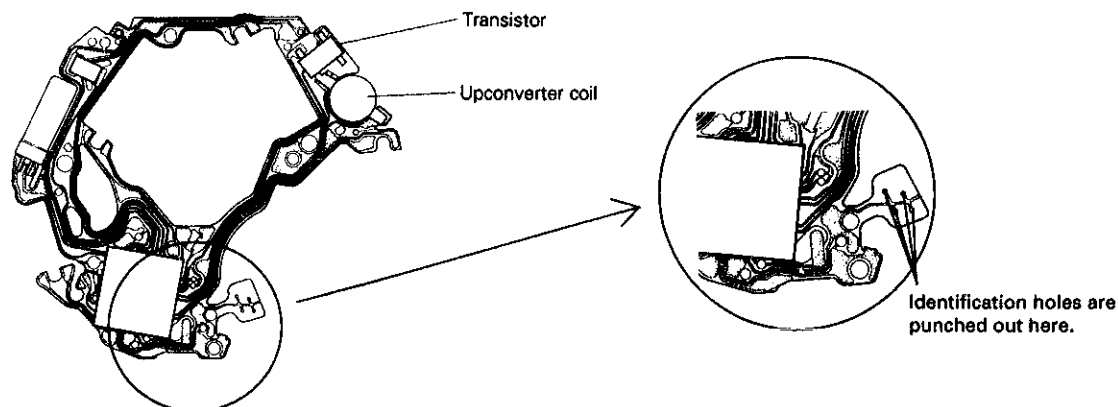

Note: The circuit block for Cal. 7T24A does not have a transistor or an upconverter coil.

PARTS CATALOGUE

Cal. 7T24A, 7T34A, 7T36A, 7T44A

Cal. No.	7T24A	(7T32A)	7T34A 7T36A	(7T42A) 7T44A	(5T52A)
Parts code	4000 705	4000 700	4000 706	4000 701	4000 704

* The table includes Cal. 7T32A, 7T42A and 5T52A.

56 76 Clutch wheel

The shape of clutch wheel differs depending on calibres. To identify the clutch wheels for respective calibres, check the number of the teeth and the length of A shown in the illustration, referring to the table below.

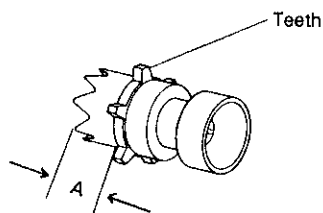

Cal. No.	Parts code	Length of A	Number of teeth
(5T52A) (7T32A) (7T42A)	282 580	short	12
7T24A 7T34A 7T44A	282 583	long	6
7T36A	282 584	long	12

TECHNICAL GUIDE

Cal. 7T24A, 7T34A, 7T36A, 7T44A

- The explanation here is only for the particular points of Cal. 7T24A, 7T34A, 7T36A and 7T44A. For other information, refer to "PARTS CATALOGUE/TECHNICAL GUIDE" for Cal. 7T32A and Cal. 7T42A, whose mechanism and functions are basically the same as those of the calibres above.
- For the repairing, checking and measuring procedures, refer to the "TECHNICAL GUIDE, GENERAL INSTRUCTIONS".

I. STRUCTURE OF THE CIRCUIT BLOCK

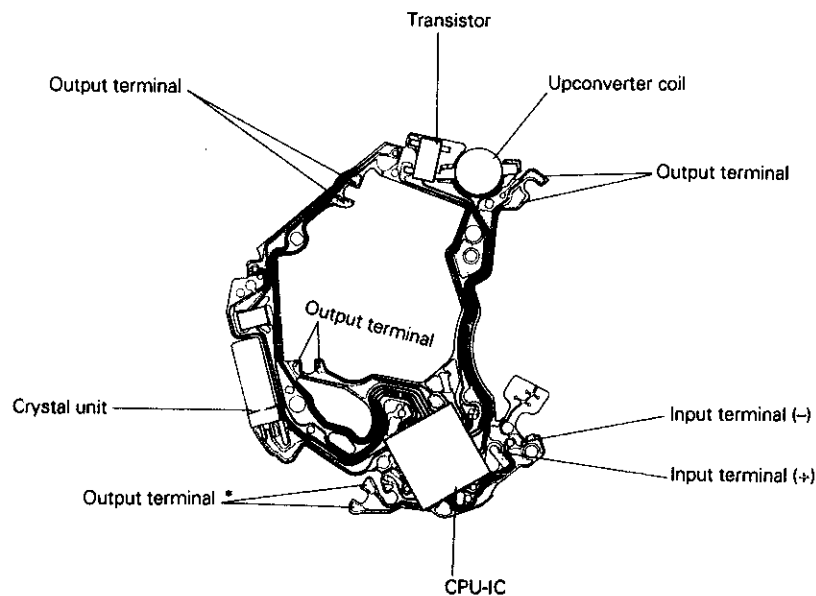

Note: The circuit block for Cal. 7T24A does not have a transistor or an upconverter coil.

II. REMARKS ON INSTALLING THE BATTERY

- A necessary step after installing the battery
 - After the battery is replaced with a new one, or after the battery is re-installed following the repairing procedures, be sure to short-circuit the AC terminal and the circuit block cover with tweezers to reset the circuit as shown in the illustration below.

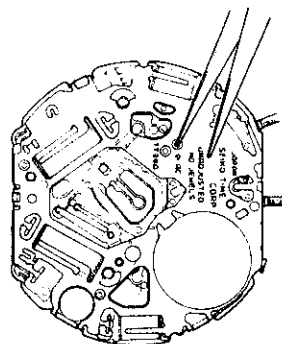

TECHNICAL GUIDE

Cal. 7T24A, 7T34A, 7T36A, 7T44A

- After resetting the circuit, be sure to reset the stopwatch hands to the 12 o'clock position.
 - 1) Pull out the crown at the 3 o'clock side to the second click.
 - 2) Press button "B" to reset the stopwatch second hand to "0".
 - 3) Press button "A" to reset the stopwatch minute hand to "0".

* With each press of buttons "B" and "A", the stopwatch second and minute hands move 0.2 seconds and 0.5 minutes, respectively. They move automatically while the buttons are kept pressed and stop when they are released.

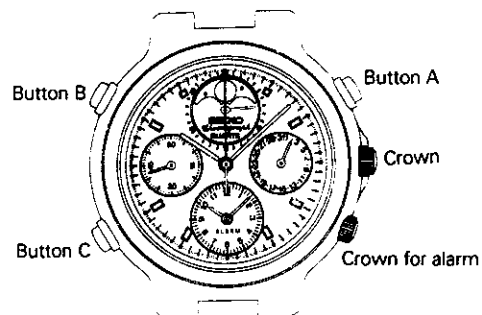

III. REMARKS ON DISASSEMBLING AND REASSEMBLING

①9 ②3 Date star guard

②1 Moon phase indicator guard

• How to remove

- 1) Pry up the hooking portion of the guard by using the tip of a screwdriver.
- 2) Slide the guard and remove it.

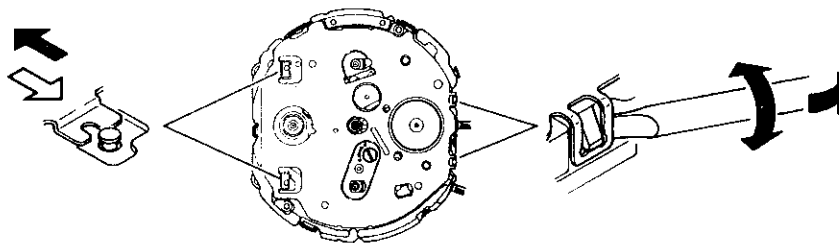

③4 ④7 Spacer for center wheel and pinion

• Setting position and lubricating

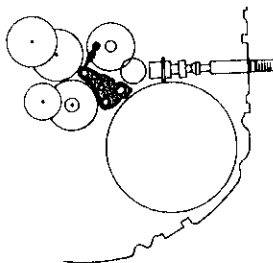

TECHNICAL GUIDE

Cal. 7T24A, 7T34A, 7T36A, 7T44A

31 Pin for train wheel bridge

• **Lubricating**

After setting the fixing pin for train wheel bridge, lubricate the axle holes for step rotor, chronograph rotor for second and chronograph rotor for minute of the train wheel bridge.

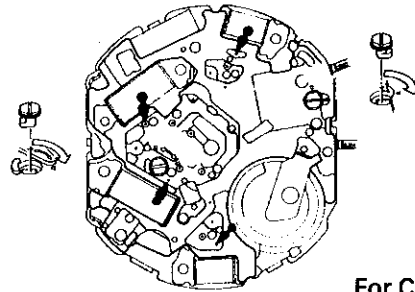

For Cal. 7T24A

43 Pin for train wheel bridge

• **Lubricating**

After setting the fixing pin for train wheel bridge, lubricate the axle holes for step rotor, chronograph rotor for second, chronograph rotor for minute and step rotor for alarm of the train wheel bridge.

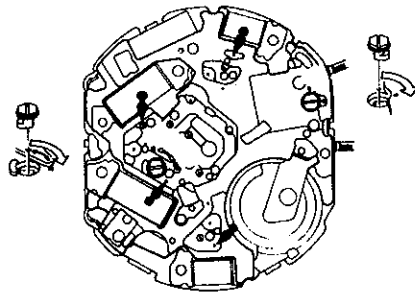

For Cal. 7T34A, 7T36A, 7T44A

52 **69** Switch lever A

• **Lubricating**

After installing the switch lever A, lubricate as shown in the illustration.

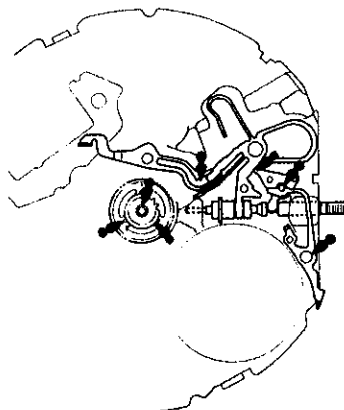

Cal. 7T24A

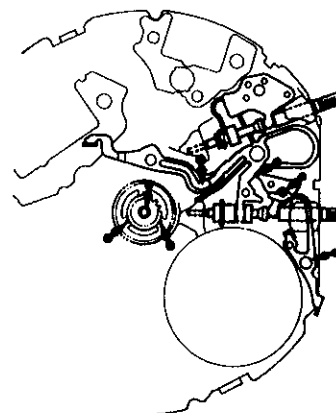

Cal. 7T34A, 7T36A, 7T44A

TECHNICAL GUIDE

Cal. 7T24A, 7T34A, 7T36A, 7T44A

64 Main plate

• Lubricating

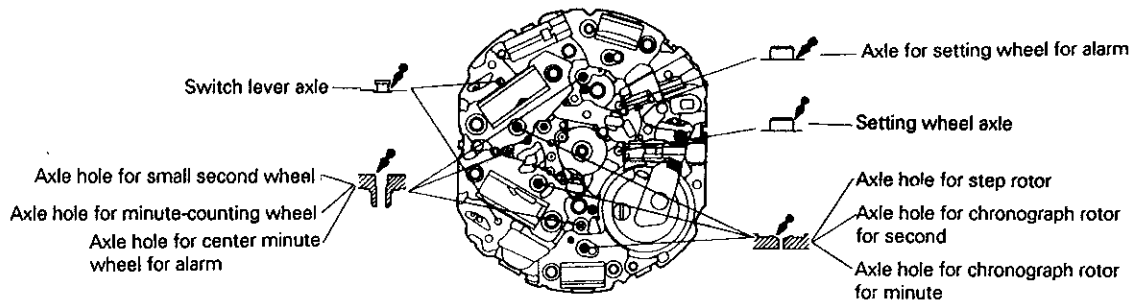

Cal. 7T24A

85 Main plate

• Lubricating

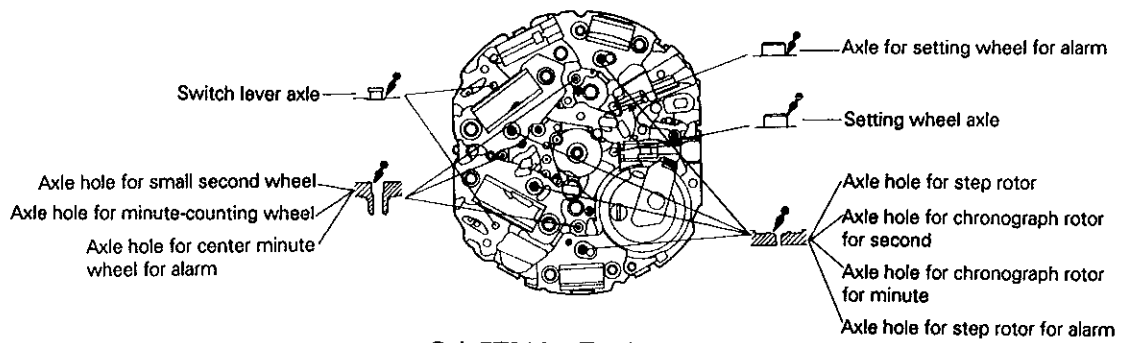

Cal. 7T34A, 7T36A, 7T44A

22 Spacer for moon phase indicator

• **How to remove**

Remove the spacer for moon phase indicator by using a screwdriver as shown in the illustration.

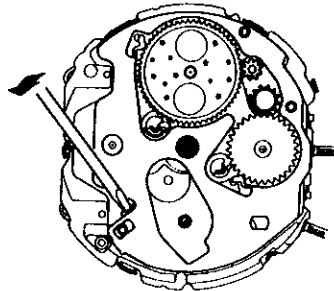

25 Moon phase indicator

• **How to install**

After installing the moon phase indicator, engage the spring for moon phase jumper and the spring for date jumper with the gears of the moon phase indicator and the date star, respectively, as shown in the illustration.

• **Lubricating**

Lubricate the date jumper only.

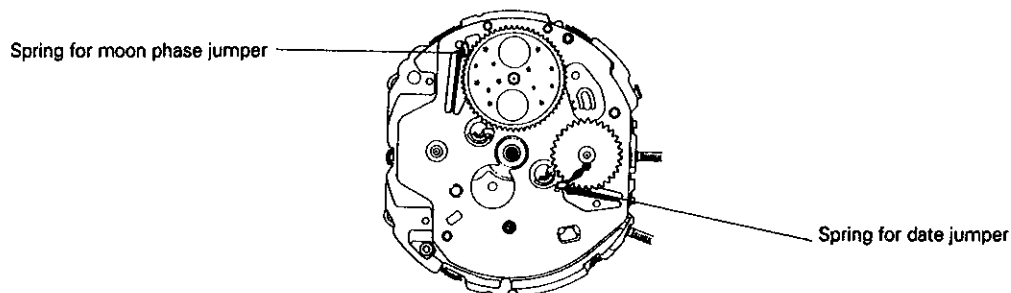

34 Hour wheel ~ **28** Third intermediate wheel for calendar correction

• **Setting position**

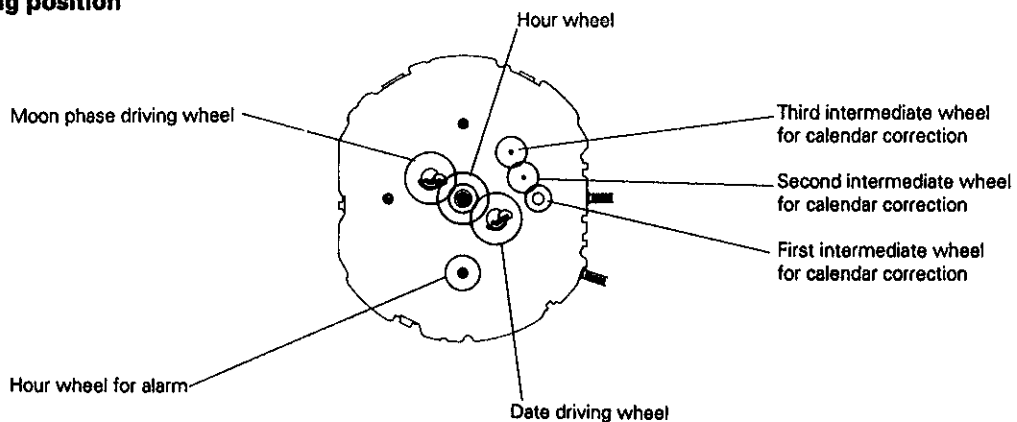

The first intermediate wheel for calendar correction are identical with the second intermediate wheel for calendar correction though named differently, and the moon phase driving wheel and the date driving wheel are also identical.

TECHNICAL GUIDE

Cal. 7T36A

31 Moon phase driving wheel

32 Date driving wheel

Set the moon phase driving wheel and the date driving wheel as shown in the illustration below so that the day and moon phase change correspondingly.

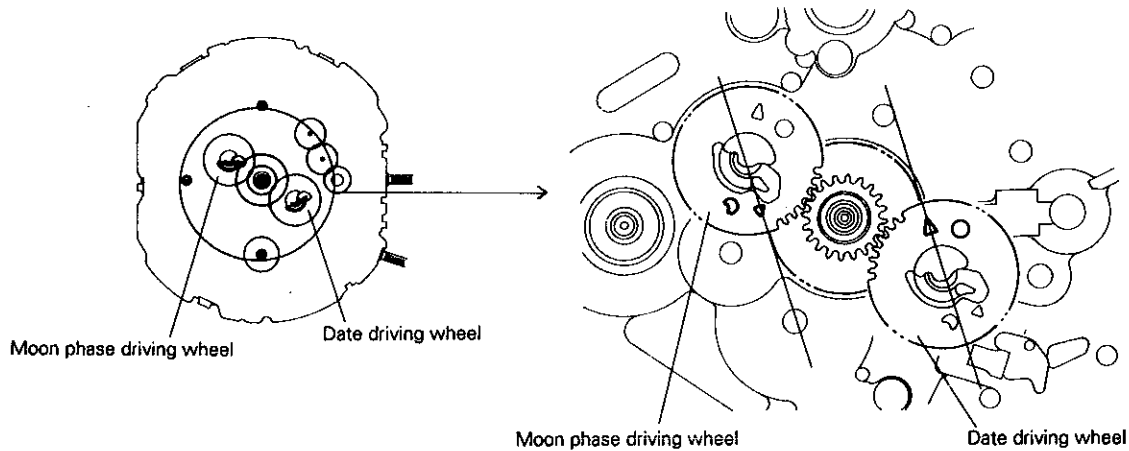

Moon phase driving wheel : Set the arrow mark beside " D " so that it points to the circumference of the hour wheel.

Date driving wheel : Set the arrow mark beside " O " so that it points to the circumference of the hour wheel.

• **Checking the setting of the moon phase driving wheel and the date driving wheel**

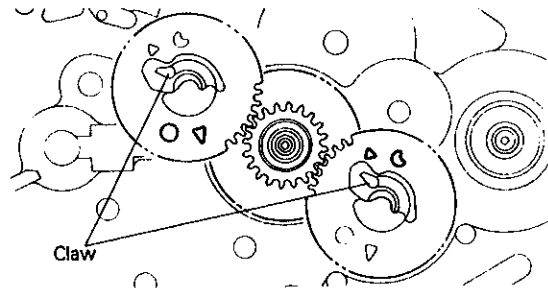

After installing the moon phase indicator guard, check if the claws of the moon phase driving wheel and the date driving wheel appear in the holes (A) and (B), by following the procedure below.

- 1) Pull out the crown to the second click and turn it clockwise so that the claw of the moon phase driving wheel appears in the hole (A) as shown at right. ☐
- 2) Check if the claw of the date driving wheel appears in the hole (B) as shown below. If so, both driving wheels are set correctly. ☐ ● ● ●
- 3) If the claw of the date driving wheel does not appear in the hole (B), set both driving wheels again.

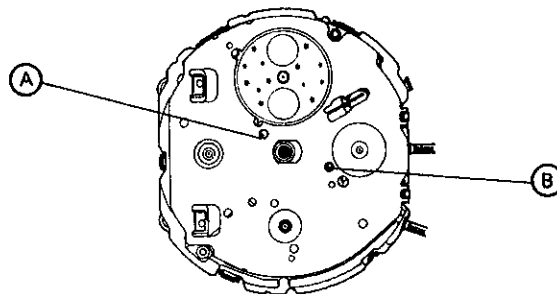

<Wheels and rotors for Cal. 7T24A>

- (33) Second counting wheel ~ (48) Chronograph rotor for minute

After disassembling the wheels and rotors, arrange them as indicated in the illustration below to facilitate the reassembling procedures. However, the rotors should be kept separately from each other, as they emit magnetism.

• **Setting position**

Set the illustration below.

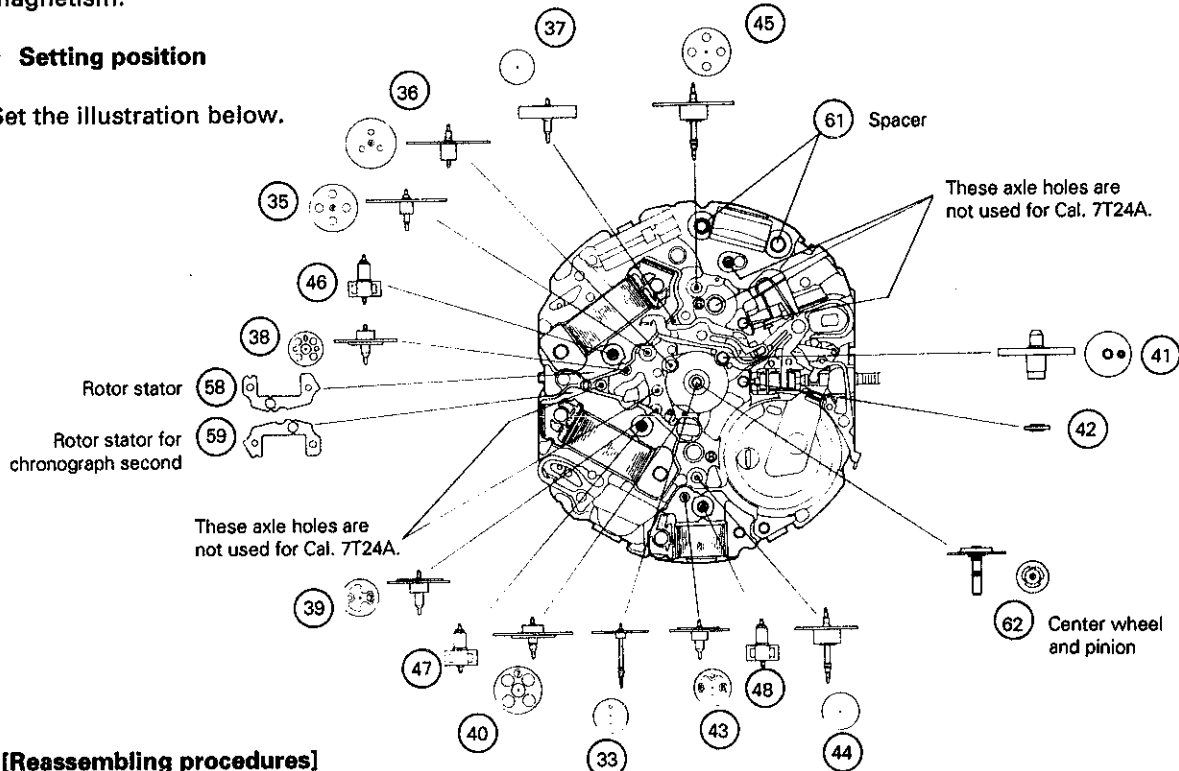

[Reassembling procedures]

• Reassemble the parts below in the following order.

- | | |
|---|---|
| 1) (48) 4146 700
Chronograph rotor for minute
(Plastic: white) | 9) (40) 885 581
Second intermediate wheel for second-
counting (Plastic: green) |
| 2) (47) 4146 700
Chronograph rotor for second
(Plastic: white) | 10) (39) 885 580
First intermediate wheel for second-
counting (Plastic: white) |
| 3) (46) 4146 700
Step rotor (Plastic: white) | 11) (38) 701 580
Fifth wheel and pinion (Plastic: green) |
| 4) (45) 240 582
Small second wheel (Metal: gold) | 12) (37) 817 582
Intermediate small second wheel
(Metal: silver) |
| 5) (44) 902 580
Minute-counting wheel (Metal: gold) | 13) (36) 231 580
Third wheel and pinion (Metal: gold) |
| 6) (43) 950 580
Intermediate minute-counting wheel
(Plastic: white) | 14) (35) 241 583
Fourth wheel and pinion (Metal: gold) |
| 7) (42) 281 580
Setting wheel (Metal: silver) | * 15) (34) 4283 581
Spacer for center wheel and pinion |
| 8) (41) 261 580
Minute wheel (Plastic: white) | 16) (33) 888 580
Second-counting wheel (Metal: gold) |

* To set the spacer for center wheel and pinion, see page 14.

Note: The numerals inscribed on the main plate and plastic wheels refer to the block No.

< Wheels and rotors for Cal. 7T34A, 7T36A, 7T44A >

- 45** Second-counting wheel ~ **64** Chronograph rotor for minute

After disassembling the wheels and rotors, arrange them as indicated in the illustration below to facilitate the reassembling procedures. However, the rotors should be kept separately from each other, as they emit magnetism.

• **Setting position**

See the illustration below.

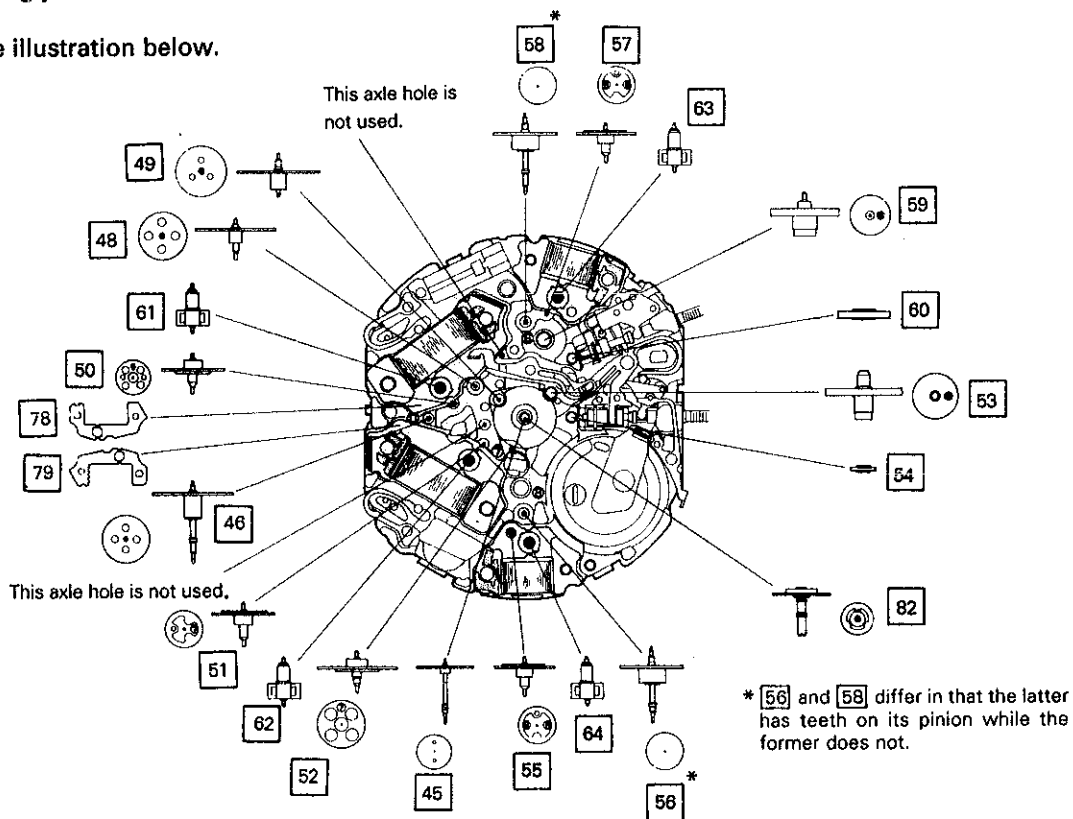

[Reassembling procedures]

• For the reassembling procedures of the parts below, refer to the exploded view on p. 10.

- | | |
|---|---|
| 82 221 583, 221 584
Center wheel and pinion (Metal: gold) | 63 4146 700
Alarm rotor (Plastic: white) |
| 79 4239 701
Rotor stator for chronograph second | 62 4146 700
Chronograph rotor for second (Plastic: white) |
| 78 4239 700
Rotor stator | 61 4146 700
Step rotor (Plastic: white) |
| 64 4146 700
Chronograph rotor for minute (Plastic: white) | |

TECHNICAL GUIDE

Cal. 7T34A, 7T36A, 7T44A

- Reassemble the parts below in the following order.

- | | |
|--|---|
| 1) 60 281 582
Setting wheel for alarm (Metal: white) | 9) 52 885 581
Second intermediate wheel for second-counting
(Plastic: green) |
| 2) 59 261 582
Minute wheel for alarm (Plastic: white) | 10) 51 885 580
First intermediate wheel for second-counting
(Plastic: white) |
| 3) 58 270 580, 270 581
Center minute wheel for alarm (Metal: gold) | 11) 50 701 580
Fifth wheel and pinion (Plastic: green) |
| 4) 57 950 580
Intermediate alarm wheel (Plastic: white) | 12) 49 231 580
Third wheel and pinion (Metal: gold) |
| 5) 56 902 580, 902 581
Minute-counting wheel (Metal: gold) | 13) 48 241 583
Fourth wheel and pinion (Metal: gold) |
| 6) 55 950 580
Intermediate minute-counting wheel
(Plastic: white) | *14) 47 4283 581
Spacer for center wheel and pinion |
| 7) 54 281 580
Setting wheel (Metal: white) | 15) 46 240 580, 240 584
Small second wheel (Metal: gold) |
| 8) 53 261 580
Minute wheel (Plastic: white) | 16) 45 888 582, 888 583
Second-counting wheel (Metal: gold) |

* To set the spacer for center wheel and pinion, see page 14.

Note: Setting positions of wheels and rotors are the same as those for Cal. 7T32A.

IV. VALUE CHECKING

- **Coil block resistance**

Coil block for alarm	:	1.8K Ω ~ 2.4K Ω (except for Cal. 7T24A)
Coil block for chronograph minute	:	1.8K Ω ~ 2.4K Ω
Coil block for chronograph second	:	1.7K Ω ~ 2.3K Ω
Coil block	:	1.7K Ω ~ 2.3K Ω

- **Upconverter coil resistance:** 45 Ω ~ 60 Ω

- **Current consumption**

Before measuring current consumption, be sure to reset the circuit.

* Refer to "A necessary step after installing the battery".

For the whole of the movement

Time mode	:	less than 2.5 μ A
Stopwatch mode	:	less than 9.5 μ A

For the circuit block alone

Time mode	:	less than 1.8 μ A
-----------	---	-----------------------

- **Time accuracy**

When measuring the accuracy of Cal. 7T34A, 7T36A and 7T44A, make sure that the crown for alarm (at the 4 o'clock side) is at the first or second click position.